

PO Box 7987
Edmond, OK 73083
14710-A Metro Plaza Blvd
Edmond, OK 73013

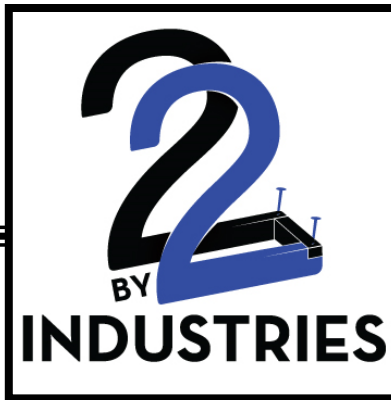

O: 877-234-6558
F: 405-607-0624
info@2by2ind.com

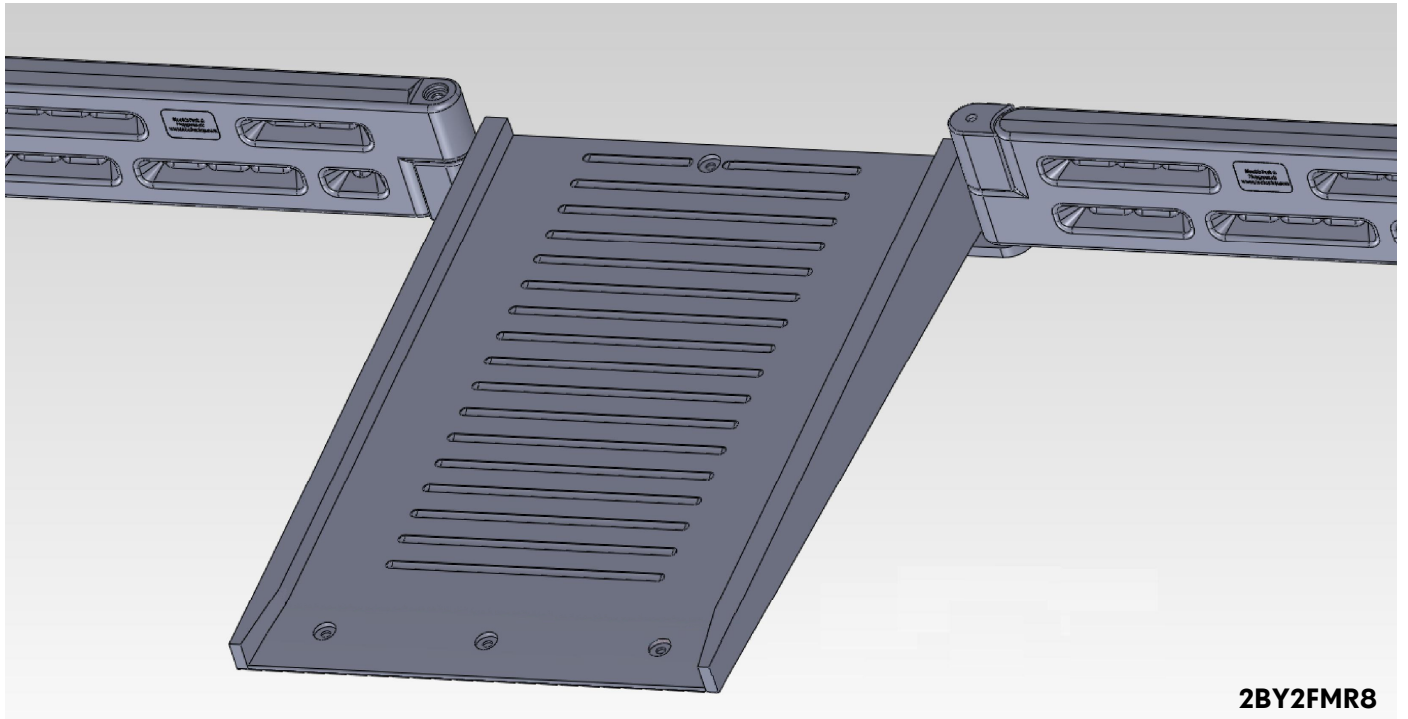

2BY2FMR8

8" Flush Mount Ramp

INSTALLATION INSTRUCTIONS AND MATERIALS LIST

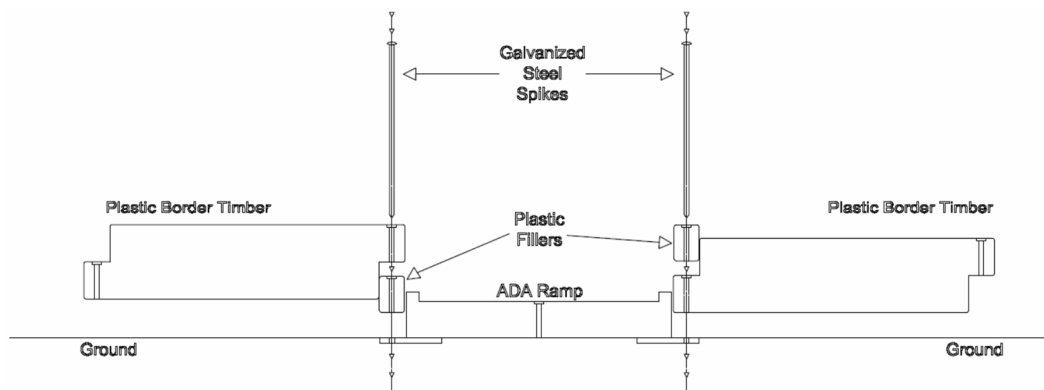

PO Box 7987
Edmond, OK 73083
14710-A Metro Plaza Blvd
Edmond, OK 73013

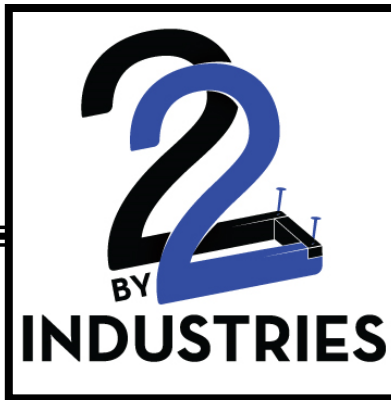

O: 877-234-6558
F: 405-607-0624
info@2by2ind.com

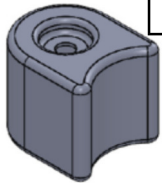

20" spike sent with border timbers goes into this "ear"

Two (2) Countersunk, pre-drilled Filler End Caps are Included

These are sized according to plastic border timbers being used, 12" or 8"

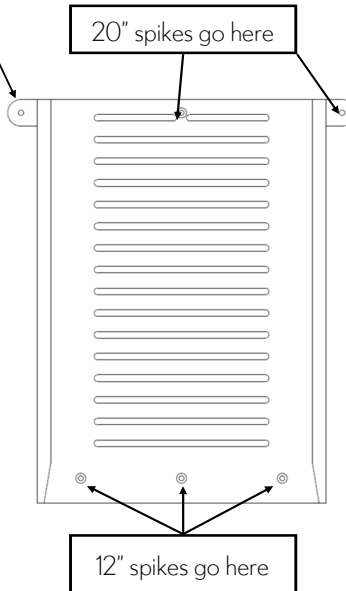
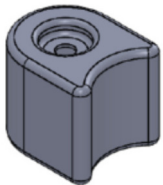

Five (5)
Galvanized Steel
Pin-Head Spikes Included
*diagram to the left specifies
which size goes where

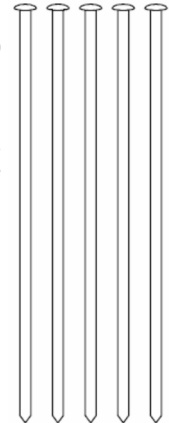

One (1) Half-Ramp

This ADA Half Ramp has been designed to work universally with any manufacturer's plastic border timber, provided its method of attachment involves a 3/4" diameter steel spike. You have the freedom to use 6", 8", or 12" plastic playground border timbers because the attachment point sits BENEATH the timber.

Here are three easy steps to complete the installation of your new ADA Ramp from 2by2 Industries:

1. Place the Half Ramp in its allocated space between the plastic border timbers.
2. Secure each side of the ramp to the border timbers using the 20" galvanized steel spike. Use the included plastic fillers to fill the gaps created from the upper and lower portions of the plastic border timbers, respectively.
 - If you are using 8" border timbers, your fillers will each be 4" tall.
 - If you are using 12" border timbers, your fillers will each be 6" tall.
4. Once secured in its desired location, secure a spike in each of the remaining countersunk holes in the ramp. There is one in the center at the peak of the ramp (20") and three more at the entrance/exit portions of the ramp (12"). In total, there will be four (4) spikes secured in the ramp itself and one (1) securing the ramp to the plastic border timber (20").

NOTE: The existing plastic border timbers that create the perimeter of the play zone should have come with the spike needed to secure itself to the ramp. If you are missing any spikes or plastic border timbers, please reach out to your preferred playground equipment dealer!